

“Flight into Fantasy” Lead Castings

These lead casting kits come with hand-casted figures, full-size patterns & assembly instructions. This special alloy will accept black patina. You make the wings and tails from stained glass.

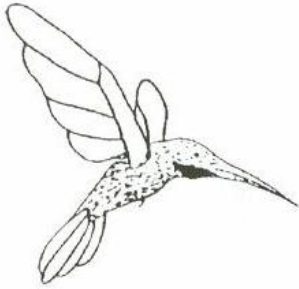

Hummingbird Body
#139903 \$19.95



Hovering Hummingbird
#139908 \$19.95



Small Hummingbird (2)
#139905 \$27.95



Flying Butterfly
#139910 \$13.95

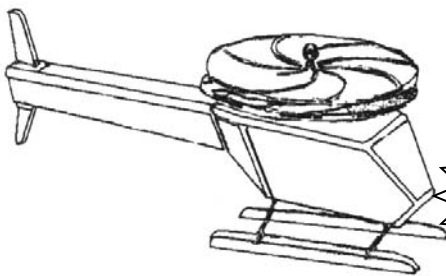

**ASGS
Instructor
Endorsed!**

Kaleidocopter Kit #621211 \$32.95
Create a truly one-of-a-kind gift with this kit. Includes patterns, detailed instructions and all optical parts. Just add stained glass for a unique gift sure to be remembered.

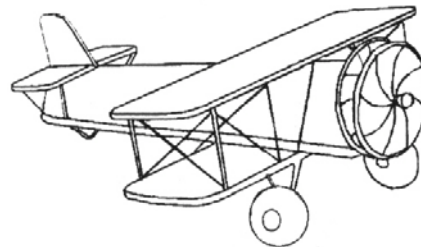

**ASGS
Instructor
Endorsed!**

Aeroscope Kit #621147 \$32.95
Create a truly one-of-a-kind gift with this kit. Includes patterns, detailed instructions and all optical parts. Just add stained glass for a unique gift sure to be remembered.

Lost Planetscope Kit #621208 \$39.95
A unique design that creates amazing optical images. The easy to assemble kit includes patterns, detailed instructions, optical parts and oil wands. Just add stained glass for hours of amusement.



**ASGS
Instructor
Endorsed!**

Oil Wandscope Kit #621192 \$32.95
Try this amazingly easy to assemble scope kit that creates terrific optical images. The kit includes patterns, detailed instructions, optical parts and oil wands. Just add stained glass for hours of amusement.

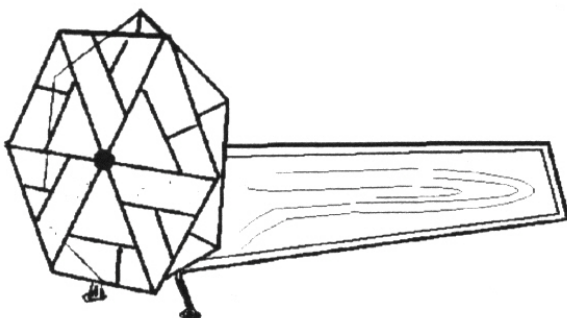
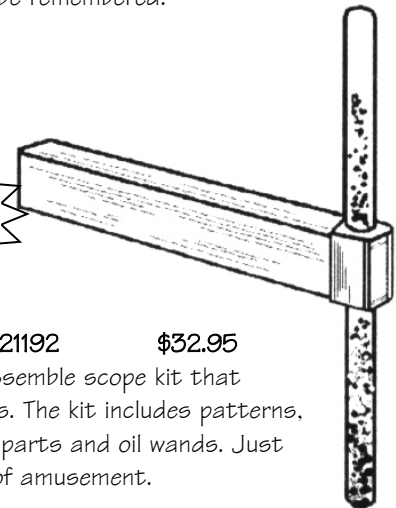

Kaleidoscope Hardware #621161 \$6.95
Includes the axle pack hardware needed to create a stained glass kaleidoscope.

Kaleidoscope Mirror Assembly #621120 \$6.95
Three strips of double-sided, high optical quality mirror used specifically to product a clear, crisp image in a kaleidoscope.



3/8" Brass Hinge #219382 \$0.95
5/8" Brass Hinge #219582 \$0.95

These pre-assembled, solid brass hinges are easily soldered to jewelry boxes, frames or whatever your imagination desires. Sold in 2 packs.



7mm Brass Ball Feet (4) #219070 \$2.95
10mm Brass Ball Feet (4) #219100 \$3.95

These solid brass spheres are tapped for attachment to 1/8IP threads or can be easily soldered for feet, handle, pulls, etc. Sold in 4 packs.

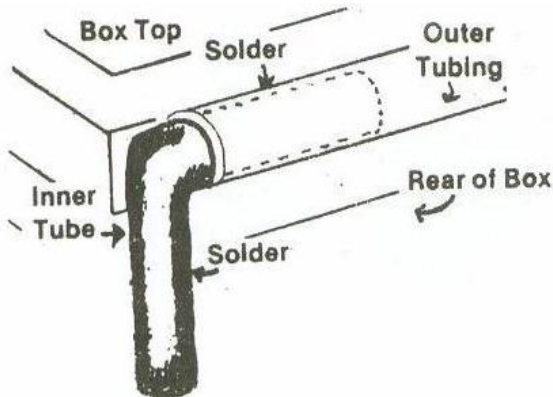

Jewelry Box Tube Hinges

The larger, hollow tube is soldered to the back of the jewelry box, while the thinner tube is inserted in the outer tube, bent at 90° at the ends and soldered into the box sides.

Inner Rod (12")
 #219580 \$1.00

Outer Tube (12")
 #219581 \$1.50



Brass Finish #258862 \$3.95
Copper Finish #258863 \$3.95
Steel Finish #258864 \$3.95

These box feet, available in filigree (above) or solid (below), are easily soldered to jewelry boxes, kaleidoscopes and much more. Sold in 4 packs.



Brass Finish #258992 \$3.95
Copper Finish #258993 \$3.95
Steel Finish #258994 \$3.95

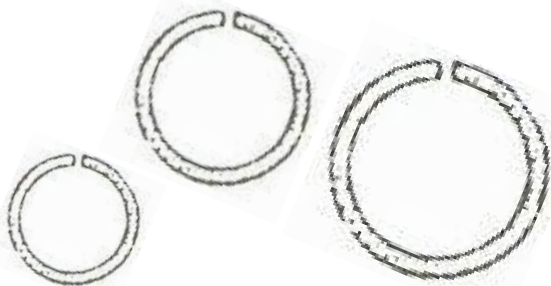

Jump Rings

1/4" Rings (25 Pack) #071814 \$1.25
7/16" Rings (25 Pack) #071716 \$2.95
3/4" Rings (25 Pack) #071340 \$3.95

Perfectly formed rings ready to solder into your suncatchers, panels & more!



Panel Chain

Copper #073813 **Pewter** #073814
Black #073815 **Antique Brass** #073816

Will support projects up to 15lbs in weight. Sold by the foot.
 All finishes \$1.95/foot.



Fine Jewelry Chain

Copper #073803 **Pewter** #073805
Nickel #073804

Perfect for use on boxes, jewelry and as decorative accents. Sold by the foot. All Finishes \$1.95/foot.

Emphrem's Bottle Cutter

#070203 \$63.95

Have you ever wondered what to do with all your empty soda, wine and assorted bottles? Why not convert them into glassware, storage ware & candle holders? It's now possible with the help of this bottle cutter. The sturdy, all metal frame is easily adjusted to accept bottles of all sizes. The nylon rollers protect the glass from marring during scoring. The 3-head cutting turret features tungsten carbide composition, ensuring the heads stay honed sharper, longer. This is a lifetime investment... in fact, it carries a life-time guarantee! (Please note - guarantee does not apply to the cutting heads.)

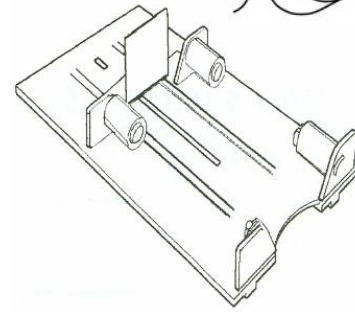

Mark-Stay (1 oz. Jar)

#381555 \$8.95

With glass bandsaws more popular than ever, users are looking for a solution to the problem of the marker washing off during cutting. Look no further! Simply rub a small amount of Mark-Stay over the marker line and it will repel the water and preserve the mark. Washes up easily with soap & water.

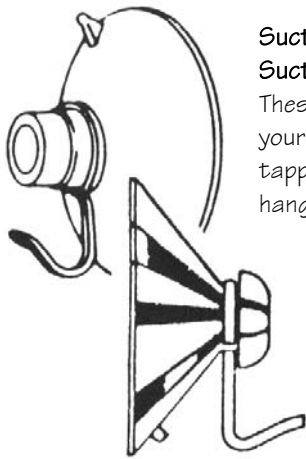

Suction Cup (1)

#071903 \$0.30

Suction Cups (100 Bag)

#071904 \$24.95

These soft cups offer excellent traction for your suncatcher & small projects. Features a tapped hole, ridged lip & metal hook for easy hanging. 1-1/2".

Horseshoe Nails (25 Pack)

#079903 \$5.95

These nifty nails are used in lead came to keep the lead pinned in place prior to soldering.



Pre-Tinned Copper Wire

16 Gauge (12 ft)	#072216	\$3.95
18 Gauge (25 ft)	#072218	\$5.95
20 Gauge (25 ft)	#072220	\$3.95
22 Gauge (25 ft)	#072222	\$2.95
20 Gauge Twisted (10 ft)	#079920	\$4.95
22 Gauge Twisted (10 ft)	#079922	\$3.95

~ 1/4 lb. & 1 lb. Spools Available ~ Call for Details

Remember: the higher the number ... the thinner the wire.



Did you know...?

Mosaics pre-date stained glass by centuries! Artisans would craft elaborate designs on walls, floors and pools by using stone, terracotta, obsidian and anything they could lay their hands on! The pieces were broken into shapes, attached by whatever adhesive was available and kept in place using sand and mortar. How do we know this to be true? These designs were durable enough to withstand centuries of weathering. As a matter of fact, so versatile and durable was the mosaic, that the first roads introduced by the Romans were technically mosaics!



Chemical Brush

#070302 \$0.30

Features stiff bristles crimped into a metal handle. Used to apply flux, patinas & etching cream.

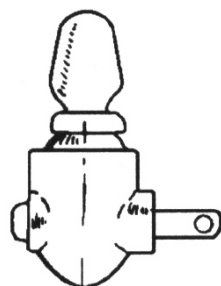

Nightlight Assembly

#087025 \$5.95

Brass Nightlight Bracket

#087026 \$1.00

Brass Nightlight Bracket (50)

#087027 \$29.95

Heavy duty UL listed nightlight assembly. Comes complete with bracket and 7-1/2 watt bulb.



Lead Stop Blocks (25)

#24025 \$9.95

Use these high strength polymer blocks to replace the scrap lead customarily used to prevent the horseshoe nails from chipping the glass and to raise the glass level with lead.



Mosaic Stone Colorant is a highly concentrated pigment specially designed for use with Flashcrete. The vibrant, solid colors are perfect to add finesse to your decorative stepping stones! Each 3 oz. package will brightly color from up to 200 lbs. of Flashcrete!



Sandstone Colorant	#060257	\$3.95
Yellow Colorant	#060259	\$3.95
Rose Colorant	#060261	\$3.95
Brick Red Colorant	#060263	\$3.95
Plum Colorant	#060265	\$3.95
Blue Colorant	#060267	\$8.95
Green Colorant	#060269	\$8.95
Terra Cotta Colorant	#060271	\$3.95
Brown Colorant	#060273	\$3.95
Charcoal Colorant	#060275	\$3.95

Flashcrete Mosaic Cement #060507 \$29.95
 Formulated specifically for outdoor decorative mosaic stepping stones, this formulation doesn't require reinforcement or sealant. Dries quick ... in about 1 hour! Special colloidal structure makes the stone super strong and smooth! Use Mosaic Stone Colorant to create custom color with Flashcrete's special color chart. Easy to use and mix for mess-free and quality results every time! 20 lb. box.



MosaicArt Handtools

Finely crafted tools are designed specifically for mosaics. Each tool is comfortable to work with, yet heavy duty in construction to ensure a long life! These precision tools are crafted specifically for the art of mosaics and decorative stepping stones. These durable tools will nip glass, ceramic and stone up to 1/4" thick.

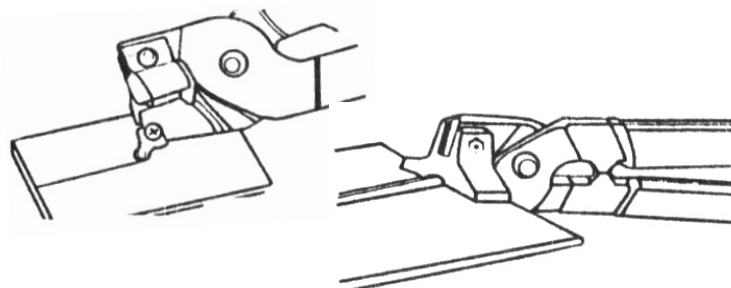
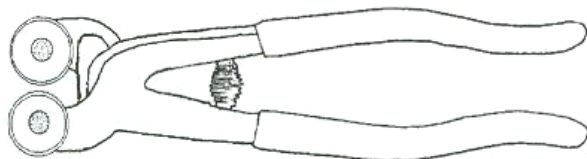

Wheeled Glass Nippers #060491 \$36.95
 Heavy duty mosaic tool with comfort grip handles featuring long life carbide wheels perfectly beveled for "nipping" glass into shape. Spring loaded handles for "always open" operation.

Mosaic Scorer & Breaker #060493 \$21.95
 Heavy duty mosaic tool with comfort grip handles features a tungsten carbide cutting wheel for superior long-life & cutting precision. Will score & break glass or tile up to 1/4" thick.

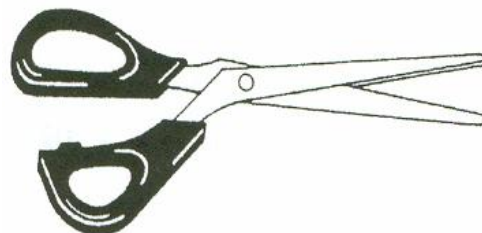
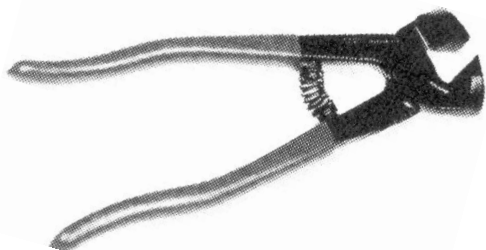

Mosaic Tile Nippers #060492 \$29.95
 Heavy duty mosaic tool with comfort grip handles featuring beveled jaws for nipping both tile & glass. Spring loaded handles for "always open" operation.

Mosaic Shears #201225 \$18.95
 Until now, it was almost impossible to gauge how much of the pattern line to remove for the mosaic & decorative stepping stones. Remove too much and the mosaic looks "clunky" ... remove too little and the glass may peel out. Each cut with these newly engineered shears removes the perfect amount every time!

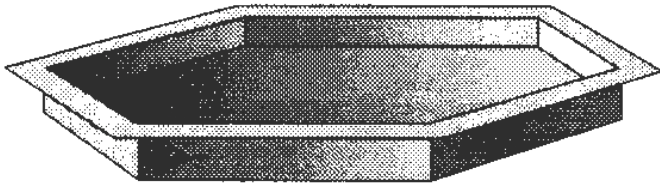

12" Hexagon #060378 \$19.95
16" Hexagon #060110 \$26.95

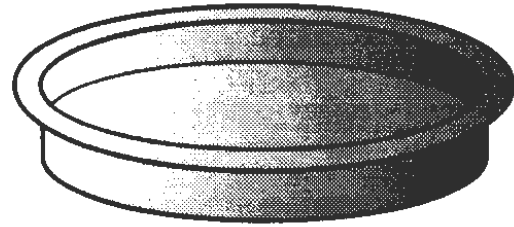

8" Round #060111 \$12.95
12" Round #06044 #19.95
14" Round #060106 \$19.95
18" Round #060208 \$29.95

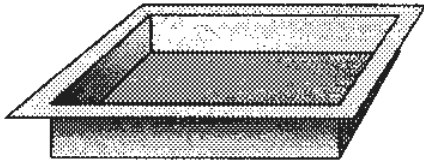

8" Square #060109 \$12.95
12" Square #060379 \$19.95
16" Square #060107 \$29.95

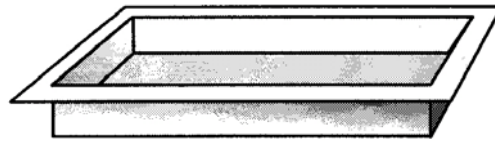

16" x 6" Rectangle #060441 \$26.95

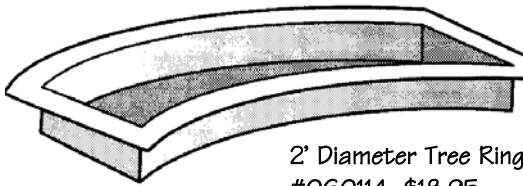

2" Diameter Tree Ring #060114 \$18.95

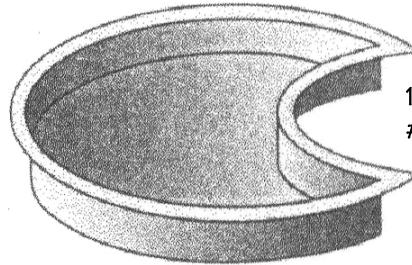

18" Moonstone #060112 \$34.95

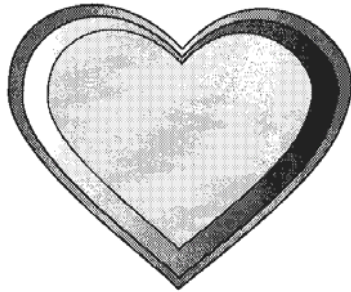

9" Heart #060586 \$18.95

9-1/2" Butterfly #060587 \$18.95

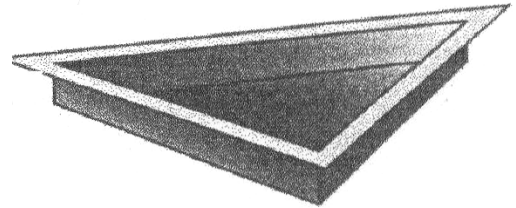
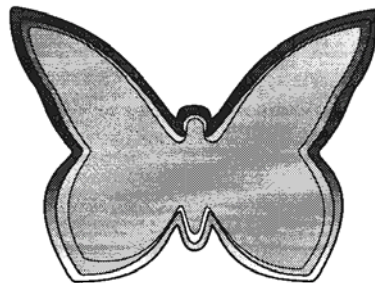

11" x 11" x 16" Triangle #060108 \$22.95

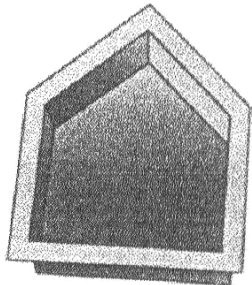

6" House Border #060113 \$14.95
Doorstop Mold #060105 \$13.95

Diamond Tech



International

Buy with confidence! All Diamond Tech Mosaic Art
Molds carry a lifetime warranty!

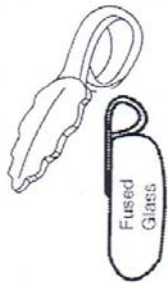

Small Nickel Jewelry Bails (25)	#132261	\$24.95
Small Nickel Jewelry Bails (6)	#132261-6	\$6.95
Large Nickel Jewelry Bails (25)	#132263	\$24.95
Large Nickel Jewelry Bails (6)	#132263-6	\$6.95
Small Gold Plated Jewelry Bails (25)	#132264	\$34.95
Small Gold Plated Jewelry Bails (6)	#132264-6	\$8.95

Place a drop of E-6000 (#5219) in the divot on the bail and adhere to your favorite piece of fused glass jewelry. Available in large (10mm x 25mm) or small (6mm x 15mm); nickel or gold plate; and sold in 6 packs or bags of 25.

Small Earring Bails (24)	#132265	\$29.95
Small Earring Bails (6)	#132265-6	\$7.95

Place a drop of E-6000 (#5219) in the divot on the bail and adhere to your favorite piece of fused glass jewelry. This 6mm x 15mm finding is available in nickel finish; and in sets of two or in bags of 24.



Flat Top Letter Opener	#484221	\$12.95
Round Top Letter Opener	#484222	\$12.95
Short Mandrel Letter Opener	#484223	\$12.95
Long Mandrel Letter Opener	#484224	\$12.95

Create fun and function art with these stainless steel letter openers. Decorate the surfaces or mandrels with fused glass or beads for a gift that will never be forgotten.

Flat Top Bottle Stopper	#132231	\$12.95
Round Top Bottle Stopper	#132232	\$12.95
Short Mandrel Bottle Stopper	#132413	\$12.95

Create fun and function art with these stainless steel wine bottle stoppers. Decorate the surfaces or mandrels with fused glass or beads for a truly whimsical gift that will never be forgotten.



Door Pull for Fused Glass	#132290	\$9.95
---------------------------	---------	--------

Yet another innovative product to marry fun with functionality! Apply a drop of E-6000 (#5219) to glue a fused glass accent into the recess to create a truly one-of-a-kind cabinet door pull! Solid, durable stainless steel construction.

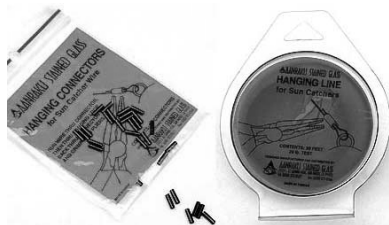

Suncatcher Hanging Line (30 feet)	#130350	\$5.95
Suncatcher Hanging Crimps (24)	#130351	\$5.95

Flexible, but strong, Suncatcher Hanging Line is a great replacement for wire or fishing line. Use the connectors to close the loop instead of trying to tie a knot. The connector is easy to crimp with pliers. Simply run the line through the connector, then through the stained glass hanging loop, back through the connector, and crimp with pliers. It's fast & easy without a knot that may come undone.



Mirror Silver Protector (4 oz.)	#385065	\$12.95
---------------------------------	---------	---------

A must have product to protect that sensitive mirror edge before foiling or leading and soldering. Failure to do so may result in "black rot" - the loss of the mirroring/silver surface around the mirror edges. Apply with small brush, allow to dry 2-4 hours before applying copper foil and solder.